

# PRICE LIST 2020

POUL KJÆRHOLM

EURO, EXCL. VAT / 01.2020

# FRITZ HANSEN

# CONTENT

## 03 • GENERAL TERMS AND CONDITIONS

### CHAIRS

- 04 • PK8™
- 05 • PK9™
- 06 • PK11™

### LOUNGE AND SOFAS

- 07 • PK22™
- 08 • PK25™
- 09 • PK26™
- 10 • PK31™
- 11 • PK80™
- 12 • PK81™
- 13 • PK33™
- 14 • PK91™
- 15 • PK24™
- 16 • PK20™

## TABLES

- 17 • PK71™
- 18 • PK61™/PK61A™
- 19 • PK51™/PK55™
- 20 • PK54™/PK54A™
- 21 • PK58™
- 22 • PK40™
- 23 • PK65™
- 24 • PK62™
- 25 • PK63™/PK63A™

## 26 • SURFACE SELECTION

# GENERAL TERMS AND CONDITIONS

## CURRENCY & EFFECTIVE DATE

This price list is valid from 01.01.2020 and cancels all prior price lists.

All prices are in Euro excl. VAT.

Reservation is made for any errors and omissions. Furthermore, below general terms and conditions shall apply to all contracts under which Fritz Hansen A/S (Fritz Hansen) is the supplier/subsupplier.

## ORDER CONFIRMATION

Orders shall not be binding on Fritz Hansen until the customer has received Fritz Hansen's written order confirmation.

## ORDER CANCELLATION

Orders can be cancelled in accordance with the below rules:

	ORDERS CANCELLED 0-3 DAYS AFTER ORDER CONFIRMATION HAS BEEN SENT	ORDERS CANCELLED LATER THAN 3 DAYS AFTER ORDER CONFIRMATION HAS BEEN SENT
STANDARD PRODUCTS	NO FEE	FEE: 5% OF NET PRICE EXCL. VAT.
SPECIALS OR MODIFIED PRODUCTS	FEE: FULL PRICE	

## DELIVERY

Denmark: DDP INCO-Terms 2000 (delivery address)  
 Countries within the EU: DDP INCO-Terms 2000 (delivery address)  
 European countries outside the EU: DDU INCO-Terms 2000  
 USA: DDP INCO-Terms 2000 New York  
 Japan: DDP INCO-Terms 2000 Tokyo  
 Middle East, Russia, Asia, South and Central America, Australia, Canada:  
 EXW INCO-Terms 2000

Goods must be picked up at the Fritz Hansen warehouse no later than 20 calendar days after the confirmed shipping date of the consolidated order. If the goods are not picked up, Fritz Hansen will charge the customer 20 DKK / 2.5 EURO / 3 USD per day per package. If the customer so desires, Fritz Hansen can deliver at the end consumer's address against an additional fee.

## COMPLAINTS

The physical product must be inspected upon delivery. Damage incurred in transit as well as any defects and deficiencies on the product incurred as a result of transportation must be recorded on the freight bill upon delivery. Fritz Hansen must be notified in writing of any complaints about product defects and deficiencies within 24 hours of delivery. If the complaint is made in due time and with the acceptance of Fritz Hansen, the customer is entitled to demand a replacement delivery or to have the defect remedied. The customer cannot demand a reduction or a compensation. Complaints/replacements can only be made to the customer's address, unless delivery has been made directly to the end consumer.

## TERMS OF PAYMENT

Terms of payment are prepayment or thirty days net cash from invoice date. Invoices are issued and dated when the goods are dispatched. In case of late payment, interest will be charged at a rate of 1.5 % for every month or part thereof as from the due date. Interest invoices are payable net cash within eight days. Fritz Hansen can decide that the customer shall pay in advance, if the customer's balance is or has previously been due, or if the order amount exceeds the credit limit approved by Fritz Hansen.

## OBSERVATION OF TITLE

Title to the goods shall not pass to the customer until Fritz Hansen (or any third party to whom Fritz Hansen has assigned its rights to the purchase price) has received the full purchase price and been reimbursed any expenses incurred.

## WARRANTY

Fritz Hansen provides a five-year warranty on standard products against defects in materials and workmanship. The warranty does not extend to ordinary wear, tear or damage to upholstery. The warranty for wicker is two years. An extended warranty of up to twenty years is provided on selected products provided they have been registered online on FRITZHANSEN.COM/MY-FH.

No warranty is provided on products with customer's choice of leather, fabrics or materials ordered as special materials. Warranty is not provided on products modified by the customer after delivery neither. Any case of subsequent changes to the product will invalidate the warranty.

## LIMITATION OF LIABILITY

Fritz Hansen will assume no liability for any loss as a result of delays, defects or any other breach of contract, unless such loss was caused by gross negligence on the part of Fritz Hansen. Fritz Hansen will assume no liability for any indirect loss, including loss of profits, operating loss, goodwill, loss of customers, running costs or any other consequential economic loss.

## CHOICE OF LAW AND JURISDICTION

Disputes between Fritz Hansen and its customers shall be subject to Danish law, except for the international civil law rules of Danish law, and shall be settled by Fritz Hansen's home court.

## MEASUREMENTS

The stated measurements in this document act only as a guideline. The measurements can vary and size difference on a product can occur.

# MY FRITZ HANSEN EXTENDED WARRANTY OVERVIEW

WICKER

POUL KJÆRHOLM

2 YEARS

•

20 YEARS

•



**PK8™**  
POUL KJÆRHOLM 1978/2007

01.2020

The PK8™ chair comes with a shell in black or white moulded plastic with front upholstery in a limited range of leather types. The base is made of anodised satin brushed aluminium and the shell of PC/ABS plastic.

MODEL	DESCRIPTION	CATEGORY 4	CATEGORY 5
PK8	Chair, 44 cm, anodised satin brushed aluminium legs	1.890	2.306

CATEGORY 4: AURA  
CATEGORY 5: GRACE

PK8

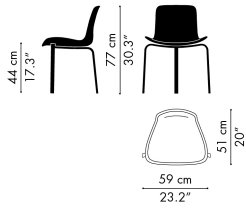



**PK9™**  
**POUL KJÆRHOLM 1960**

01.2020

The PK9™ is a fully upholstered chair in a limited range of leather types. The 3-legged base is made of satin brushed stainless spring steel. The inner shell is made of nylon.

MODEL	DESCRIPTION	CATEGORY 4	CATEGORY 5
PK9	Chair, 43 cm, satin brushed stainless spring steel legs	3.923	4.397

CATEGORY 4: AURA  
 CATEGORY 5: GRACE, EMBRACE, WHITE, OPTICAL WHITE, RUSTIK, NATURAL

**SURCHARGE**  
 DESCRIPTION

SURCHARGE

DESCRIPTION	SURCHARGE
Glides	122

PK9

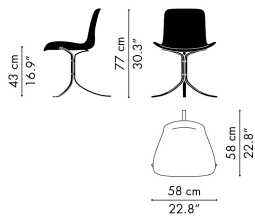



**PK11™**  
**POUL KJÆRHOLM 1957**

**01.2020**

The PK11™ armchair comes with armrests in lacquered ash and an upholstered seat in a limited range of leather types. The base is made of satin brushed stainless steel.

MODEL	DESCRIPTION	CATEGORY 4	CATEGORY 5
PK11	Armchair, 43/44 cm, satin brushed stainless steel legs	2.531	2.847

CATEGORY 4: AURA  
CATEGORY 5: GRACE, EMBRACE, WHITE, OPTICAL WHITE, RUSTIK, NATURAL

**PK11**

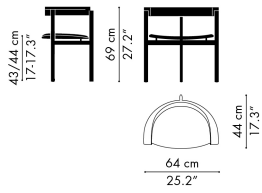



**PK22™**  
**POUL KJÆRHOLM 1956**

**01.2020**

The PK22™ lounge chair is available in wicker, canvas, suede leather as well as in a limited range of standard leather types. The base is made of satin brushed stainless spring steel.

MODEL	DESCRIPTION	WICKER	CANVAS	SUEDE	CATEGORY 4	CATEGORY 5
PK22	Lounge chair, satin brushed stainless spring steel base	2.721	2.721	3.395	3.395	3.930

CATEGORY 4: AURA  
CATEGORY 5: GRACE, EMBRACE, WHITE, OPTICAL WHITE, RUSTIK, NATURAL

CANVAS COLOURS - SEE THE SURFACE SELECTION  
NATURAL, BLACK

SUEDE COLOURS - SEE THE SURFACE SELECTION  
BLACK, BLACK BROWN, INDIAN RED

PK22

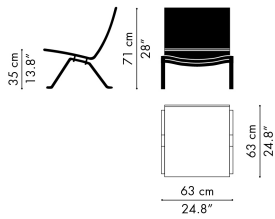



**PK25™**  
**POUL KJÆRHOLM 1951**

**01.2020**

The PK25™ lounge chair is available in flag halyard, in natural or black. The base is made of matt chromed spring steel.

MODEL	DESCRIPTION	FLAG HALYARD
PK25	Lounge chair, matt chromed spring steel base	7.949

FLAG HALYARD COLOURS - SEE THE SURFACE SELECTION  
NATURAL, BLACK

**PK25**

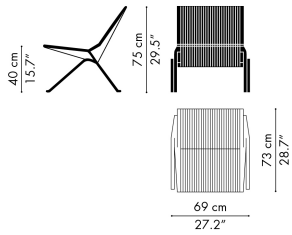





## PK26™ POUL KJÆRHOLM 1956

01.2020

The PK26™ is a wall-mounted 2-seater sofa. The frame is made in matt chromed spring steel and the cushion core is made of hairlok (pig hair/latex). The sofa is upholstered in a limited range of leather types as well as in an exclusive leather type called Niger leather (special trading terms apply).

MODEL	DESCRIPTION	CATEGORY 4	CATEGORY 5	NIGER LEATHER
PK26	2-seater sofa, wall-mounted, matt chromed spring steel frame	24.974	29.381	40.304

NOTE  
SPECIAL TRADING TERMS APPLY TO NIGER LEATHER - PLEASE CONTACT SALES SUPPORT FOR FURTHER INFORMATION: SALESUPPORT@FRITZHANSEN.COM.  
NIGER LEATHER IS ONLY AVAILABLE IN A LIMITED QUANTITY.

CATEGORY 4: AURA  
CATEGORY 5: GRACE, EMBRACE, WHITE, OPTICAL WHITE, RUSTIK, NATURAL

### PK26

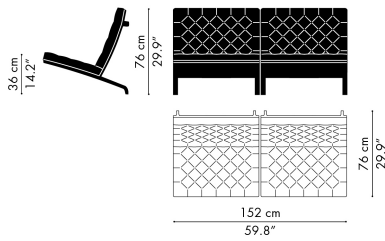



**PK31™**  
POUL KJÆRHOLM 1958

01.2020

The PK31™ series is available as a lounge chair and a 2- or 3-seater sofa. It comes in a limited range of leather types. The frame is made of matt chromed spring steel. Additional units can be added.

MODEL	DESCRIPTION	CATEGORY 4	CATEGORY 5
PK31	Lounge chair, matt chromed spring steel base	11.521	12.957
PK31/2	2-seater sofa, matt chromed spring steel base	19.201	21.729
PK31/3	3-seater sofa, matt chromed spring steel base	26.880	30.500
	Following elements for PK31, matt chromed spring steel base	7.679	8.771

CATEGORY 4: AURA  
CATEGORY 5: GRACE, EMBRACE, WHITE, OPTICAL WHITE, RUSTIK, NATURAL

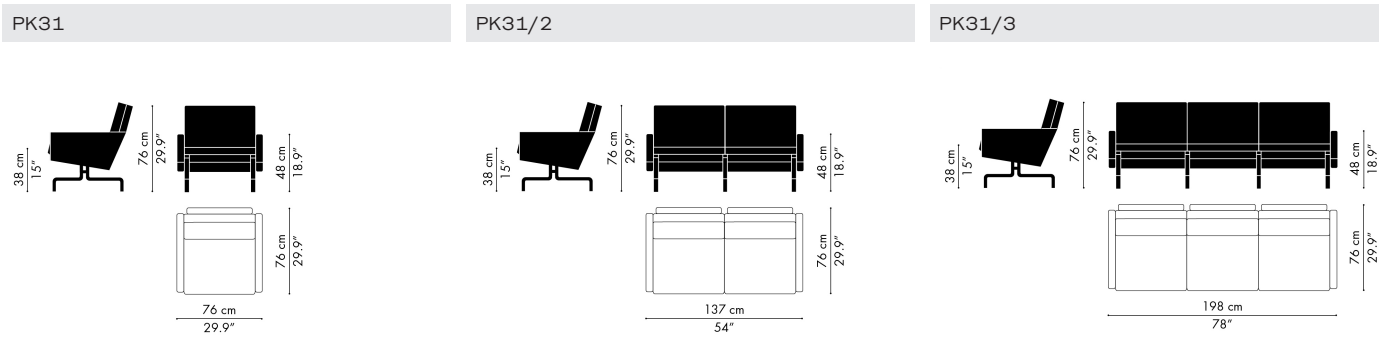

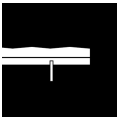

**PK80™**  
**POUL KJÆRHOLM 1957**

01.2020

The PK80™ daybed comes with a cushion upholstered in a limited range of leather types as well as in canvas. It rests on a painted plywood bedplate, and the cushion core is made of granulated foam and hairlok (pig hair/latex). The base is made of satin brushed stainless steel.

MODEL	DESCRIPTION	CANVAS	CATEGORY 4	CATEGORY 5
PK80	Daybed, satin brushed stainless steel base	8.063	12.067	13.757

CATEGORY 4: AURA  
CATEGORY 5: GRACE, EMBRACE, WHITE, OPTICAL WHITE, RUSTIK, NATURAL

CANVAS COLOURS - SEE THE SURFACE SELECTION  
NATURAL

PK80

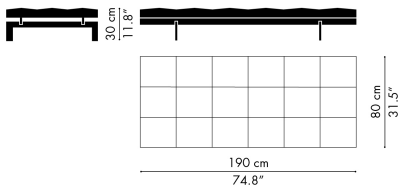

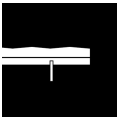

**PK81™**  
**POUL KJÆRHOLM 1959**

01.2020

The PK81™ daybed is a square version of the classic daybed PK80™. The base is made of satin brushed stainless steel and the daybed rests on a painted plywood bedplate. The cushion core is made of granulated foam and hairlok (pig hair/latex) and comes upholstered in a limited range of leather types as well as in an exclusive leather type called Buffalo leather (special trading terms apply).

MODEL	DESCRIPTION	CATEGORY 4	CATEGORY 5	BUFFALO LEATHER
PK81	Daybed, satin brushed stainless steel base	16.982	19.979	25.095

**NOTE**

SPECIAL TRADING TERMS APPLY TO BUFFALO LEATHER - PLEASE CONTACT SALES SUPPORT FOR FURTHER INFORMATION: SALESUPPORT@FRITZHANSEN.COM. BUFFALO LEATHER IS ONLY AVAILABLE IN A LIMITED QUANTITY.

CATEGORY 4: AURA  
 CATEGORY 5: GRACE, EMBRACE, WHITE, OPTICAL WHITE, RUSTIK, NATURAL

**PK81**

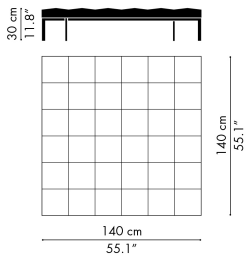



**PK33™**  
**POUL KJÆRHOLM 1959**

01.2020

The PK33™ stool is available with a detachable cushion in a limited range of leather types or canvas. The 3-legged stool has a matt chromed spring steel base.

MODEL	DESCRIPTION	CANVAS	CATEGORY 4	CATEGORY 5
PK33	Stool, matt chromed spring steel base	2.314	2.827	3.035

CATEGORY 4: AURA  
 CATEGORY 5: GRACE, EMBRACE, WHITE, OPTICAL WHITE, RUSTIK, NATURAL

CANVAS COLOURS - SEE THE SURFACE SELECTION  
 NATURAL

PK33

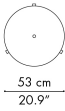



**PK91™**  
**POUL KJÆRHOLM 1961**

**01.2020**

The PK91™ folding stool is available with a seat in a limited range of leather types as well as in canvas. The base is made of satin brushed stainless steel.

MODEL	DESCRIPTION	CANVAS	CATEGORY 4	CATEGORY 5
PK91	Folding stool, satin brushed stainless steel base	2.250	2.748	2.925

CATEGORY 4: AURA  
CATEGORY 5: GRACE, EMBRACE, WHITE, OPTICAL WHITE, RUSTIK, NATURAL

CANVAS COLOURS - SEE THE SURFACE SELECTION  
NATURAL, BLACK

PK91

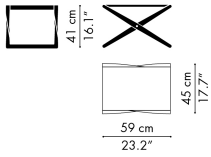



**PK24™**  
**POUL KJÆRHOLM 1965**

**01.2020**

The PK24™ chaise longue is available in a limited range of leather types or wicker.  
Both versions include a leather headrest. The base is made of satin brushed stainless spring steel.

MODEL	DESCRIPTION	CATEGORY 4	CATEGORY 5
PK24	Chaise longue, wicker, leather headrest, satin brushed stainless spring steel base	10.895	11.039
PK24	Chaise longue, leather, leather headrest, satin brushed stainless spring steel base	11.873	13.999

CATEGORY 4: AURA  
CATEGORY 5: GRACE, EMBRACE, WHITE, OPTICAL WHITE, RUSTIK, NATURAL

**PK24**

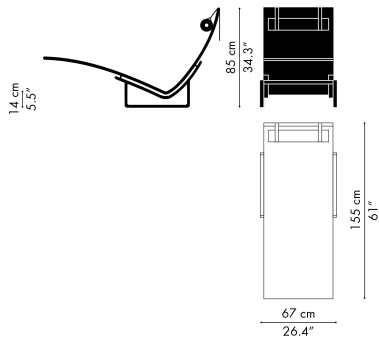



**PK20™**  
**POUL KJÆRHOLM 1968**

**01.2020**

The PK20™ lounge chair is available in a limited range of leather types or wicker. The leather version also includes a matching leather headrest. The base is made of matt chromed spring steel.

MODEL	DESCRIPTION	WICKER	CATEGORY 4	CATEGORY 5
PK20	Lounge chair, leather, leather headrest, matt chromed spring steel base		7.965	9.148
PK20	Lounge chair, wicker, matt chromed spring steel base	5.847		

CATEGORY 4: AURA  
 CATEGORY 5: GRACE, EMBRACE, WHITE, OPTICAL WHITE, RUSTIK, NATURAL

**PK20**

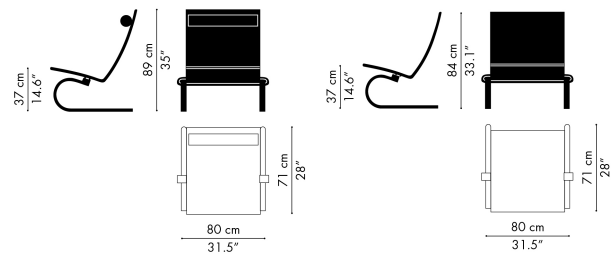



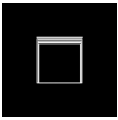

**PK71™**  
**POUL KJÆRHOLM 1957**

01.2020

The PK71™ nesting table consists of three tables with a white or black acrylic tabletop. The bases are made of satin brushed stainless steel.

MODEL	DESCRIPTION	WHITE, BLACK	H/L/W
PK71	Nesting table, 3 sizes, satin brushed stainless steel base	1.485	28.5/28/28

PK71

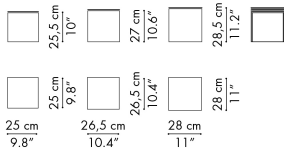



**PK61™/PK61A™**  
**POUL KJÆRHOLM 1956**

01.2020

The PK61™ coffee table comes with 4 different tabletops; slate, marble, granite and glass. PK61A™ is an enlarged version of PK61™ and is available with tabletops in marble, granite and glass. The base for both tables is made of satin brushed stainless steel.

MODEL	DESCRIPTION	SLATE	MARBLE	GRANITE	GLASS	H/L/W
PK61	Coffee table, satin brushed stainless steel base	2.792	2.792	2.792	3.262	32/80/80
PK61A	Coffee table, satin brushed stainless steel base		4.526	4.526	4.815	32/120/120

**MARBLE COLOURS - SEE THE SURFACE SELECTION**  
 WHITE (ROLLED), WHITE (HONED), GREY-BROWN (HONED), BEIGE (HONED) AND BLACK (HONED)

**NOTE**  
 THE TABLETOPS ON WHITE, GREY-BROWN, BEIGE AND BLACK (HONED) MARBLE ARE ALL UNIQUE WITH THEIR OWN PATTERN.

**PK61**

**PK61A**

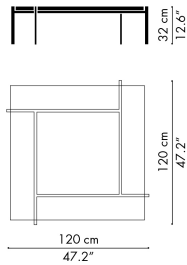
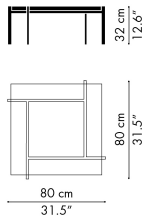



PK51™/PK55™  
POUL KJÆRHOLM 1957

01.2020

The PK51™ and PK55™ tables are available with a tabletop in ash veneer. The bases are made of satin brushed stainless steel.

MODEL	DESCRIPTION	ASH	H/L/W
PK51	Table, satin brushed stainless steel base	6.326	72/204/102
PK55	Table, satin brushed stainless steel base	4.903	72/180/90

PK51

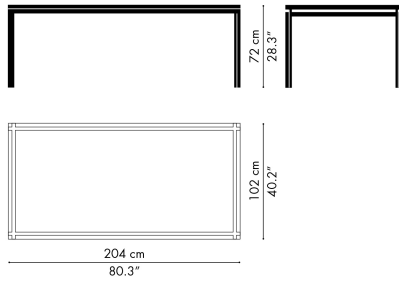

PK55

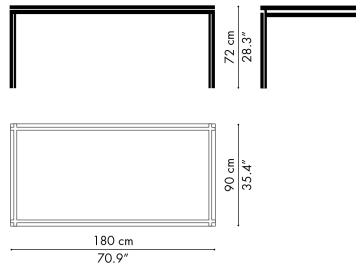



**PK54™/PK54A™**  
POUL KJÆRHOLM 1963

01.2020

The PK54™ table is available with a tabletop in marble or granite. The square base is made of satin brushed stainless steel. The circular table top has an optional expansion ring consisting of 6 sections including a storage rack, both made of natural, untreated solid maple.

MODEL	DESCRIPTION	MARBLE	GRANITE	H/Ø
PK54	Table, satin brushed stainless steel base	7.511	7.511	69/140
PK54+PK54A	Table with PK54A expansion ring, satin brushed stainless steel base	15.174	15.174	69/210

**EXPANSION RING**

MODEL	DESCRIPTION	SOLID MAPLE	
PK54A	Expansion ring, 6 sections, untreated solid maple, incl. storage rack	7.663	Ø210

MARBLE COLOURS - SEE THE SURFACE SELECTION  
WHITE (ROLLED), WHITE (HONED), GREY-BROWN (HONED), BEIGE (HONED) AND BLACK (HONED)

NOTE  
THE TABLETOPS ON WHITE, GREY-BROWN, BEIGE AND BLACK (HONED) MARBLE ARE ALL UNIQUE WITH THEIR OWN PATTERN.

PK54

PK54 +PK54A

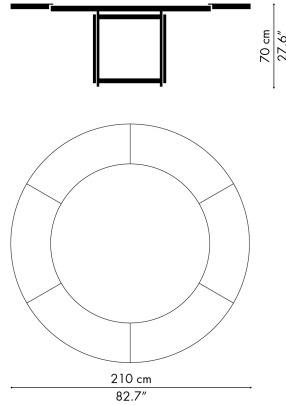
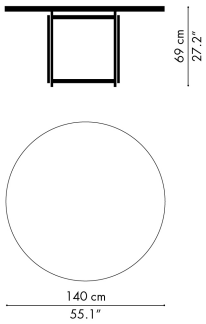



**PK58™**  
POUL KJÆRHOLM 1963/2007

01.2020

The PK58™ table comes with a white polyester composite tabletop.  
The square base is made of anodised satin brushed aluminium.

MODEL	DESCRIPTION	WHITE	H/Ø
PK58	Table, anodised satin brushed aluminium base	3.659	71/130

PK58

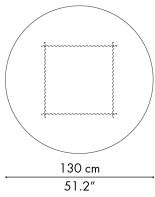
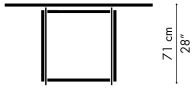



**PK40™**  
**POUL KJÆRHOLM 1980**

**01.2020**

The PK40™ table comes with an upholstered tabletop in a limited range of leather types. The base is made in satin brushed stainless steel.

MODEL	DESCRIPTION	CATEGORY 4	CATEGORY 5	H/L/W
PK40	Table, satin brushed stainless steel base	11.988	17.707	70/140/140

CATEGORY 4: AURA  
CATEGORY 5: GRACE, EMBRACE, WHITE, OPTICAL WHITE, RUSTIK, NATURAL

PK40

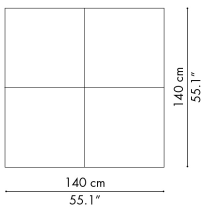



**PK65™**  
**POUL KJÆRHOLM 1979**

01.2020

The PK65™ coffee table is available with a tabletop in; slate, marble, granite and glass. The base is made of satin brushed stainless steel.

MODEL	DESCRIPTION	SLATE	MARBLE	GRANITE	GLASS	H/L/W
PK65	Coffee table, satin brushed stainless steel base	3.480	3.480	3.480	4.112	38/100/100

MARBLE COLOUR - SEE THE SURFACE SELECTION  
WHITE (ROLLED)

PK65

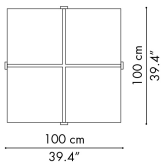



**PK62™**  
POUL KJÆRHOLM 1968

01.2020

The PK62™ side table is available with a tabletop in slate, marble and granite. The base is made of satin brushed stainless steel.

MODEL	DESCRIPTION	SLATE	MARBLE	GRANITE	H/L/W
PK62	Side table, satin brushed stainless steel	1.582	1.582	1.582	17/80/27

MARBLE COLOUR - SEE THE SURFACE SELECTION  
WHITE (ROLLED)

PK62

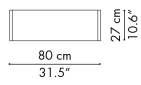





**PK63™/PK63A™**  
**POUL KJÆRHOLM 1968**

**01.2020**

The PK63™ and PK63A™ coffee tables are available with a tabletop in slate, marble or granite. The base is made of satin brushed stainless steel.

MODEL	DESCRIPTION	SLATE	MARBLE	GRANITE	H/L/W
PK63	Coffee table, satin brushed stainless steel base	3.480	3.480	3.480	31/180/60
PK63A	Coffee table, satin brushed stainless steel base	2.847	2.847	2.847	31/120/60

MARBLE COLOUR - SEE THE SURFACE SELECTION  
WHITE (ROLLED)

**PK63**

**PK63A**

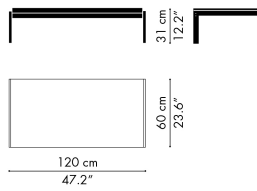
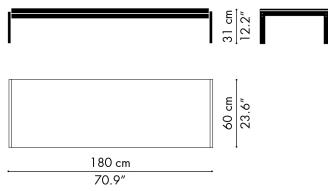

# SURFACE SELECTION

# SURFACE SELECTION

Printed colours may vary from the original colours.

## LEATHER

Please note that leather is a natural material with natural variation in colour and surface structure. The presence of scars and marks from bites etc. on the leather may occur and are characteristics of genuine leather.

### CUSTOMER'S OWN LEATHER (COL)

Customers can supply their own leather. Prices excluding leather as well as leather requirements can be given on inquiry. Please note that only very few types of leather/qualities are suitable. Fritz Hansen retains the right to reject the qualities we find unsuitable.

### SPECIAL LEATHER COLOURS

On inquiry and at a surcharge, special leather colours may be available for the models available with leather upholstery.

## AURA

PRICE CATEGORY: 4  
CHROME-TANNED, TOP-COATED, STRONG FULL-GRAIN AND DURABLE SURFACE.  
FAST TO LIGHT.  
THICKNESS 1.4-1.6 MM.



BLACK

BLACK BROWN

COGNAC

WALNUT

BRIGHT RED

## GRACE

PRICE CATEGORY: 5  
VEGETABLE AND CHROME-TANNED, ANILINE, FULL-GRAIN WITH LIGHT  
STRUCTURE AND LIGHT IMPREGNATION. BECOMES LIGHTER AND PATINATED  
WITH USE, VISIBLE NATURAL MARKINGS.  
THICKNESS 1.2-1.4 MM.

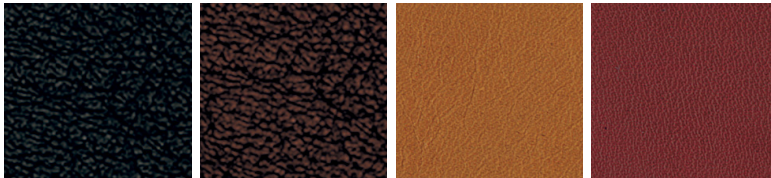

BLACK

BLACK BROWN

WALNUT

INDIAN RED

## EMBRACE

PRICE CATEGORY: 5  
CHROME-TANNED, FULLY GRAINED, EXTRAORDINARY SOFT ANILINE WITH A  
SPECIAL WAXING GIVING A SLIGHTLY 'OILY' SURFACE. COLOUR VARIATIONS,  
VISIBLE NATURAL MARKINGS E.G. NECK WRINKLES.  
THICKNESS 1.2-1.4 MM.



CONCRETE GREY

CHOCOLATE

# SURFACE SELECTION

Printed colours may vary from the original colours.

## LEATHER

### WHITE

PRICE CATEGORY: 5  
CHROME-TANNED, SEMI-ANILINE, FULL-GRAIN WITH STRUCTURE AND PROTECTIVE FINISH. PLEASE NOTE THAT WHITE IS MORE DELICATE THAN OTHER COLOURS.  
THICKNESS 1.4-1.6 MM.

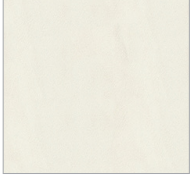

WHITE

### OPTICAL WHITE

PRICE CATEGORY: 5  
CHROME-TANNED, FULL-GRAIN, TOP-COATED AND LIGHT PROTECTIVE FINISH. PLEASE NOTE THAT WHITE IS MORE DELICATE THAN OTHER COLOURS.  
THICKNESS 1.4-1.6 MM.

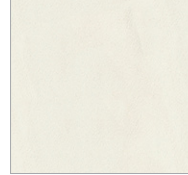

OPTICAL WHITE

### RUSTIK

PRICE CATEGORY: 5  
VEGETABLE-TANNED, CHROME-FREE, ANILINE, NO PROTECTIVE FINISH, LIGHT IMPREGNATION, VISIBLENATURAL MARKS. BECOMES LIGHTER AND PATINATED WITH USE.  
THICKNESS 1.2-1.4 MM.



RUSTIK

### NATURAL

PRICE CATEGORY: 5  
VEGETABLE-TANNED, CHROME-FREE, NATURAL LEATHER, NO COLOUR OR PROTECTIVE FINISH. BECOMES DARKER AND PATINATED WITH USE, VISIBLE NATURAL MARKINGS.  
THICKNESS 1.2-1.4 MM.



NATURAL

### SUEDE

CHROME-TANNED, ANILINE, COLOURED WITH LIGHT TREATMENT TO PROTECT AGAINST DIRT AND LIGHT.  
THICKNESS 1.9-2.0 MM.

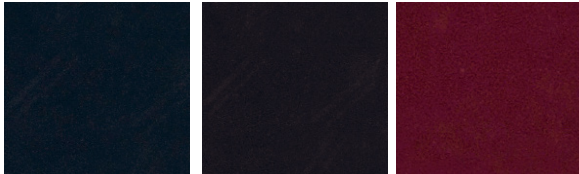

BLACK

BLACK BROWN

INDIAN RED

### NIGER

EXCLUSIVE GOAT SKIN.  
VEGETABLE-TANNED, FULLY GRAINED PURE ANILINE WITH STRUCTURE. LIGHT IMPREGNATION, VISIBLE NATURAL MARKINGS, BECOMES PATINATED WITH USE.

### BUFFALO

HIDES OF WATER BUFFALO.  
CHROME-TANNED, VERY DURABLE AND HIGH RESISTANT SURFACE. NUDE SURFACE WITH MANY VISIBLE NATURAL MARKINGS, BECOMES LIGHTER AND PATINATED WITH USE.

# SURFACE SELECTION

Printed colours may vary from the original colours.

## LOUNGE AND SOFAS

PK25™

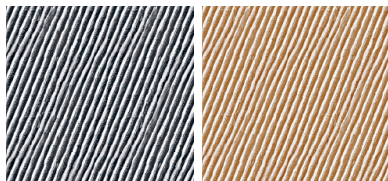

FLAG HALYARD  
100% FLAX WITH  
POLYESTER CORE  
BLACK

FLAG HALYARD  
100% FLAX WITH  
POLYESTER CORE  
NATURAL

PK22™, PK91™

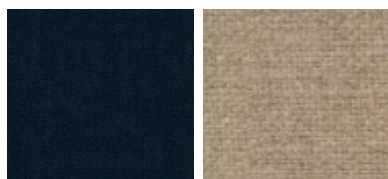

CANVAS  
100 % COTTON  
BLACK

CANVAS  
100 % COTTON  
NATURAL

PK80™, PK33™

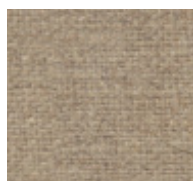

CANVAS  
100 % COTTON  
NATURAL

PK22™, PK24™, PK20™

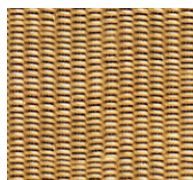

WICKER  
THICKNESS APPROX.  
2.5 MM AND 4.0 MM  
NATURAL

# SURFACE SELECTION

Printed colours may vary from the original colours.

## TABLES

### PK61™, PK61A™



MARBLE (ROLLED)  
WHITE 100



MARBLE (HONED)  
WHITE 100

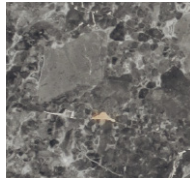

MARBLE (HONED)  
GREY BROWN 150

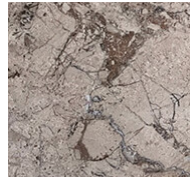

MARBLE (HONED)  
BEIGE 140

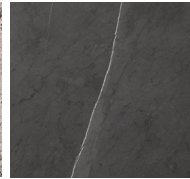

MARBLE (HONED)  
BLACK 200



GRANITE



SLATE



GLASS

### PK71™

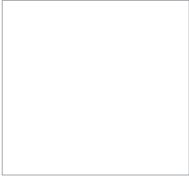

ACRYLIC  
WHITE 103

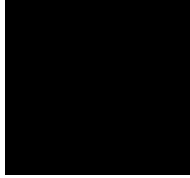

ACRYLIC  
BLACK 203

### PK51™, PK55™



VENEER  
ASH

### PK54™



MARBLE (ROLLED)  
WHITE 100



MARBLE (HONED)  
WHITE 100

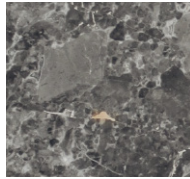

MARBLE (HONED)  
GREY BROWN 150

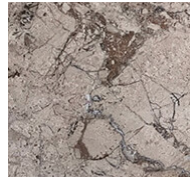

MARBLE (HONED)  
BEIGE 140

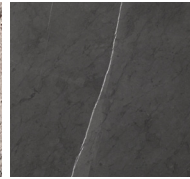

MARBLE (HONED)  
BLACK 200



GRANITE

### PK54A™ (EXPANSION RING)

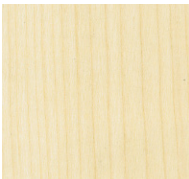

SOLID WOOD  
(UNTREATED)  
MAPLE

# SURFACE SELECTION

Printed colours may vary from the original colours.

## TABLES

PK58™



POLYESTER  
COMPOSITE  
WHITE 110

PK62™



MARBLE (ROLLED)  
WHITE 100

GRANITE

SLATE

PK63™, PK63A™

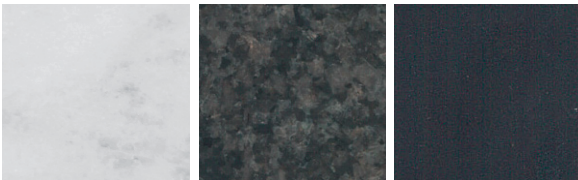

MARBLE (ROLLED)  
WHITE 100

GRANITE

SLATE

PK65™

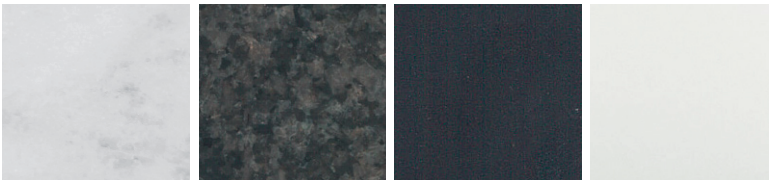

MARBLE (ROLLED)  
WHITE 100

GRANITE

SLATE

GLASS

PK40™



LEATHER  
FIND THE AVAILABLE  
LEATHER TYPES ON  
PAGE 22